

Cast Solid Bronze Safe Touch™ 150 ULTRA

PROJECT:
TYPE:
SOURCE:
NOTES:

SPECIFICATIONS IK10 IP68

LED Chip	Cree CXA 2540 field replaceable LED board
Luminaire Output	5000 Lumens @ 1400 (52watts) delivered from luminaire with unobstructed beam.
Lumens Per Watt	90 Lumens minimum @ 52 watts delivered from luminaire with unobstructed beam
CRI (3000K)	80 Standard, 90+ Optional
Colour Temperatures	2700K, 3000K, 4000K
Beam Angles	22, 33, 51, Asymmetric
Ingress Protection	IP68 <i>*not for use in pool or ponds</i>
Inverse Kinematics Rating	IK10
Maximum Load	2000kgs (4400lbs)
Warranty	Electronics = 5 years Body Cast Solid Bronze = 25 years
Standards	BS/EN 60598.2.2 cUL 1598 CE

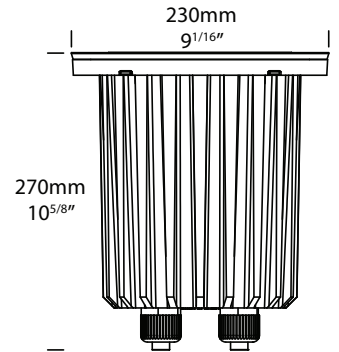

PRODUCT CONFIGURATION

Please fill in appropriate codes into boxes provided

Cat. No. ST150CSB

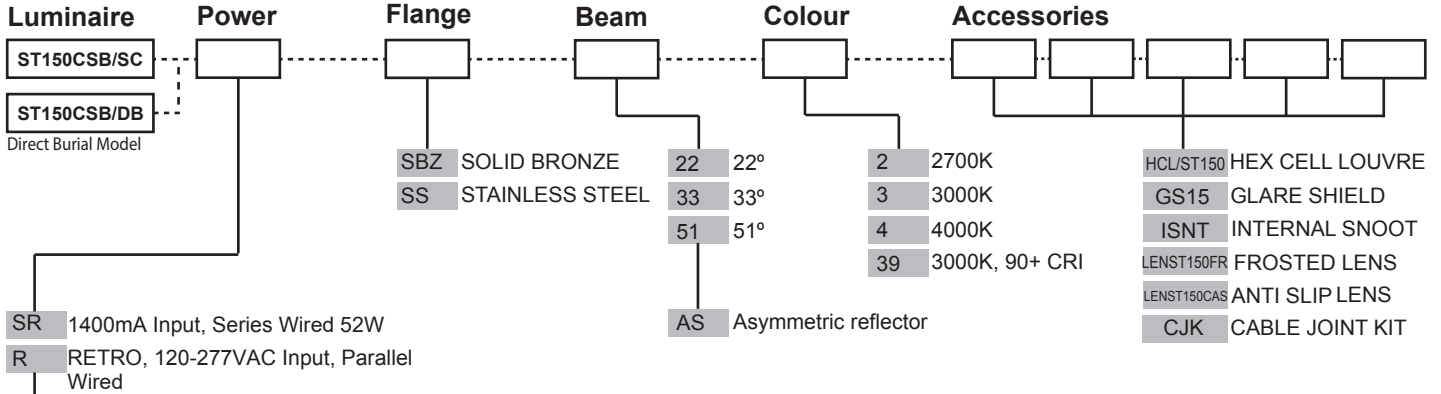

SERIES REMOTE:
Constant current driver (included). Fixture require 37vdc @ 1400mA maximum. 0-10 volt dimming.

RETRO 110-277vac DRIVER:
Constant current driver (included).
Input: 120, 240, 277 volts.
Output: 60 watts total 37vdc @ 1400mA. 0-10 volt dimming.

ADDITIONAL COMMENTS:

LUMINAIRE CONSTRUCTION

Body:
CNC machined sand cast silicon bronze.

Gaskets:
Silicone, iron impregnated 220°C (428°F).

Luminaire Weight:
12.5kg (27lb 9oz)

Flanges:
CNC machined from either Solid Bronze
260mm x 6mm (10^{1/4}" x 1/4") 316
Stainless Steel 260mm x 6mm (10^{1/4}" x 1/4").

Cable:
Water resistant rubber .

Adjustability:
The gimbal is fully adjustable, allowing 360° rotation and 0-20° elevation.

All fixings are made form 316 Stainless Steel.

Step Lens:
12mm (1/2") Extra clear, low iron, shatter resistant glass. Anti Slip option available. Lifetime warranty.

Mounting:
The ST150 is available with a spun 316 stainless steel mounting canister for casting into the ground or concrete. Maximum drive over speed 10 kp/h (6mp/h) with a maximum load rating of 2000kgs (4400lbs).

ACCESSORIES

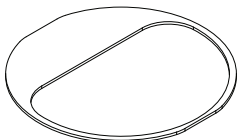

Glare Shield

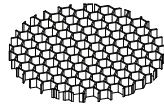

Hex Cell Louvre

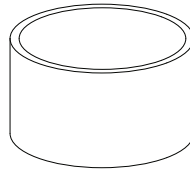

Internal Snoot

BEAM ANGLES

High efficiency Reflectors. Feild replaceable

IES files available for download: hunzalighting.com/downloads

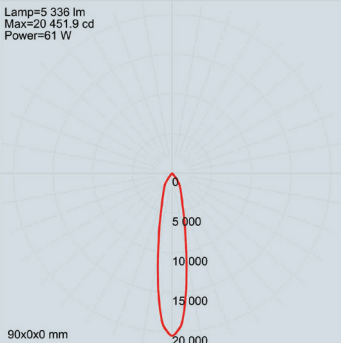

22° FWHM REFLECTOR

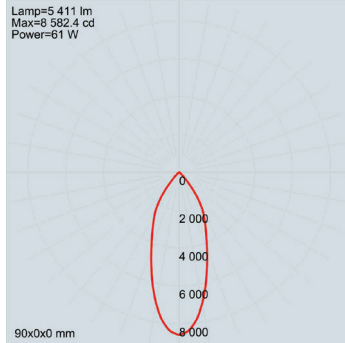

33° FWHM REFLECTOR

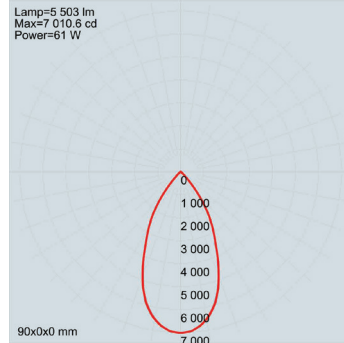

51° FWHM REFLECTOR

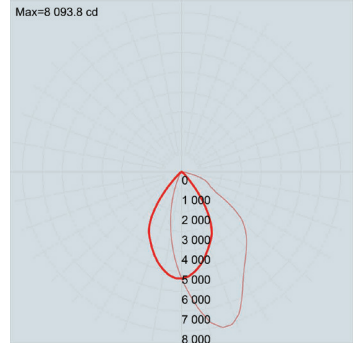

ASYMMETRIC REFLECTOR

WIRING GUIDE

Available for download: hunzalighting.com/downloads

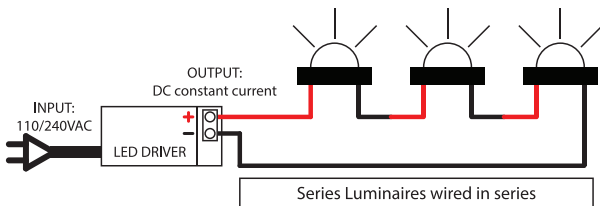

Series Luminaires wired in series

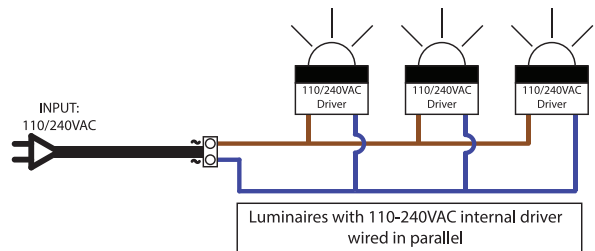

Luminaires with 110-240VAC internal driver wired in parallel

Diagrams are a guide only, wire colours and polarity may change depending on fixture and country