

Lawn Lite Cast Bronze

Cat. No. LLCAST

Cat. No. LLCASTGU



The Lawn Lite Cast Bronze is designed for insertion into a lawn or garden bed and can be mowed over without damaging the luminaire. The lamp can be directed up to 20 degrees at a bush, tree, or the outside of a building. When replacing a lamp, there is no need to remove the luminaire from the ground due to the vandal-resistant, stainless steel, screw fixing system, which attaches the flange to the body of the luminaire. The Lawn Lite Cast Bronze features a 'Flush Fit' lens to stop water pooling and depositing dirt on the lens.

A GU10 version of this luminaire is also available for line voltage lamps.

Ordering Information

Luminaire Type

LLCAST - Lawn Lite Cast Bronze
LLCASTGU - Lawn Lite Cast Bronze GU10

Accessories

CJK150 - Cable Joint Kit
HCR - Hex Cell Retainer
LENSLLF - Frosted Lens

Ordering Example: LLCAST - Lawn Lite Cast Bronze
LENSLLF - Frosted Lens
(accessories ordered separately)

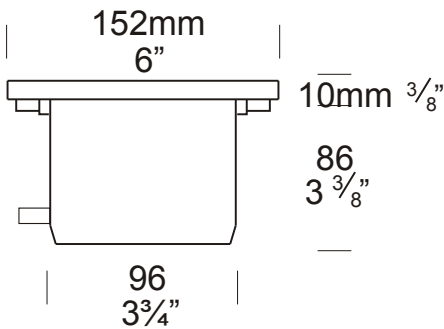

HUNZA™ PURE
OUTDOOR
LIGHTING

HUNZA FACTORY
130 Felton Mathew Ave
Glen Innes
Auckland 1072
New Zealand

Ph: 64-9-528 9471
Fax: 64-9-528 9361
hunza@hunza.co.nz
www.hunzalighting.com

INTERNATIONAL CONTACTS:
[http://www.hunzalighting.com/
contact.php](http://www.hunzalighting.com/contact.php)
Specification may change without notice.
Manufactured in New Zealand.
© 2016 Hunza Holdings Ltd.

Luminaire Construction

CNC machined from one of the following metals:

Solid Bronze

Body: cast from LG2 bronze.

Flange: solid bronze bar 150mm (6").

Mounting

The flange is attached to the body by three 316 stainless steel allen head anti vandal screws. Suitable for insertion into a lawn or gardens, etc.

Features

Lens

12mm (1/2") extra clear, low iron, flush fit, shatter resistant glass.

Lifetime Warranty.

Gasket

Nytrol 220°C (428°F).

Lamp Holder

MR16 & GU10 - 350°C (662°F) ceramic multi contact lamp holder with 250°C (480°F) Teflon cables. Lamp holder can be rotated 360° and angled up to 20°.

Accessories

Cable Joint Kit (Cat. CJK150). Not approved for USA/Canada.

Frosted Lens (Cat. LENSLLF).

Hex Cell Retainer (Cat. HCR).

Standards

IP67, UL1838, 

Luminaire Weight

Solid Bronze - 1.140kg (2lb 8oz)

Power Supply

Hunza Inground or Wall Mount Transformer: not included.

USA and Canada

Hunza Wall Mount Transformer: not included.

Lamp Options

MR16 - 20 or 35 watt lamp max.

GU10 - 25 or 35 watt lamp max.

USA and Canada

MR16 - 20 watt lamp max.

GU10 - lamp not supplied.

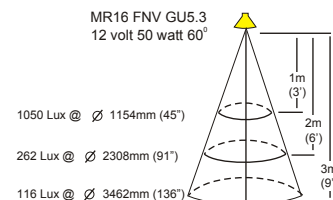
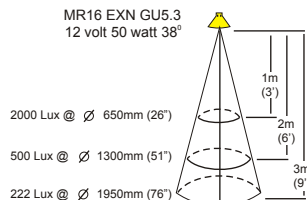
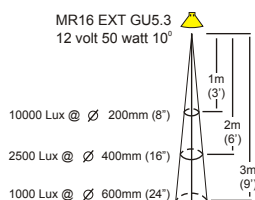
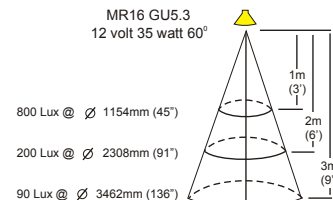
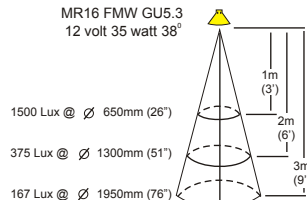
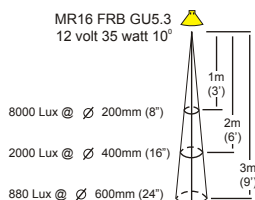
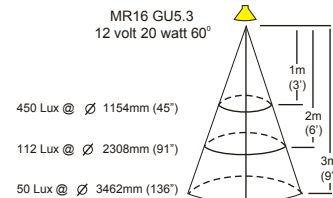
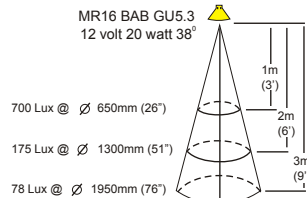
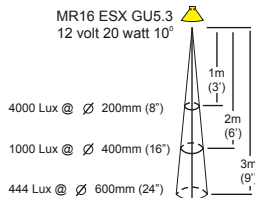

HUNZA™ PURE
OUTDOOR
LIGHTING

HUNZA FACTORY
130 Felton Mathew Ave
Glen Innes
Auckland 1072
New Zealand

Ph: 64-9-528 9471
Fax: 64-9-528 9361
hunza@hunza.co.nz
www.hunzalighting.com

INTERNATIONAL CONTACTS:
[http://www.hunzalighting.com/
contact.php](http://www.hunzalighting.com/contact.php)
Specification may change without notice.
Manufactured in New Zealand.
© 2016 Hunza Holdings Ltd.